



LED CANOPY – GC02 Series



Application: parking garages, stairwells, passageways, underpasses, and many other commercial or industrial applications.

FEATURE

- Built-in motion sensor base, allowing you to install the microwave motion or PIR sensor
- Working temperature: - 4°F ~ +104°F / -20°C ~ +40°C
- Lumen Maintenance over 70% @ 50,000+ Hours
- CRI: 80+; PF>0.9
- Beam Angle: 150°
- Body: Dark Bronze Finish. Modern design for modern and narrow space
- Low-profile design with PMMA lens gives even no glare light distribution and over 90% light transmission rate
- Watt and CCT adjustable to fit for different locations
- Surface mounted or pole mounted

ACCESSORIES

Image	Description
	Motion Sensor (Daylight Harvesting) (Sold Separately)

Dimension

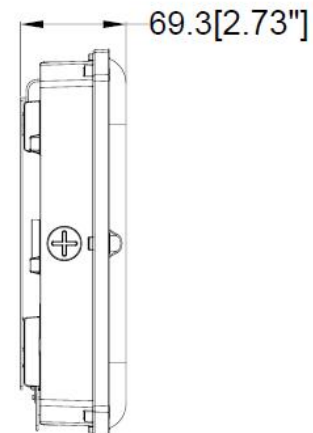
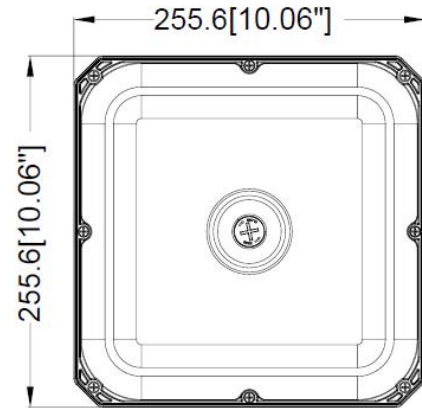

Specification

Model	HYA-GC2-40/60/80W-H-3CCT
DLC ID	S-TMNLK
Watt	40/60/80W Selectable
CCT	3500K/4000K/5000K Selectable
Lumens	10337 lm @ 80W
Dimmable	0-10V
Environment Location	Wet Location
Voltage	120-277V
OPTION	Motion Sensor
QTY/PACK	4 PCS/PACK
Package Size	15.59 in x 12.24 in x 12.24 in
Package Weight	22.66 lbs



LED GARAGE CANOPY – GC02 Series

Surface mounted Installation

1. Loosen the screw to take off the mounting plate from the lamp.

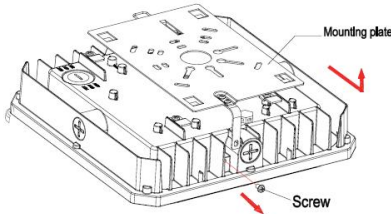

2. Screw the mounting plate to the ceiling.

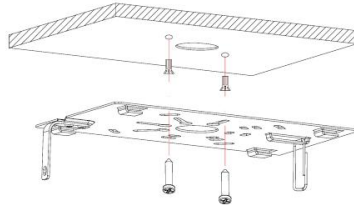

3. Hang the lamp on the ring so as to connect wires with terminal caps.

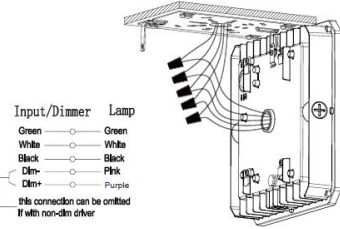

4. Hook up lamp on the mounting plate.

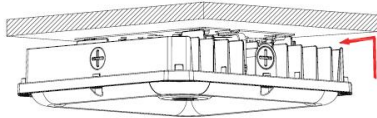

5. Secure the screw. Installation completed.

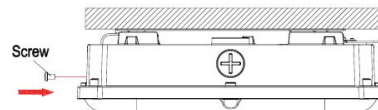

Pole mounted Installation

1. Connecting wires with terminal caps as picture shows.

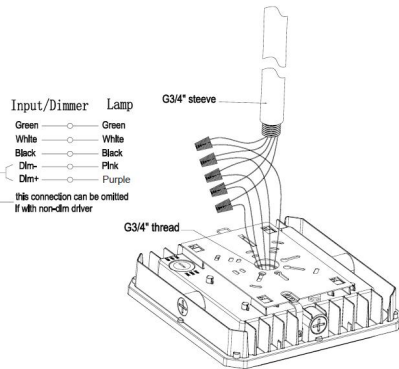

2. Rotating the sleeve to make it fixed with lamp. Installation completed.

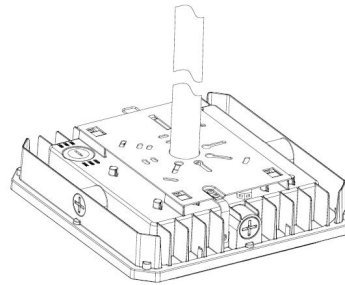

Motion Sensor Installation

1. Unscrew the PC cap on the lampshade counter-clockwise with a flat-head screwdriver on the lamp which already installed.

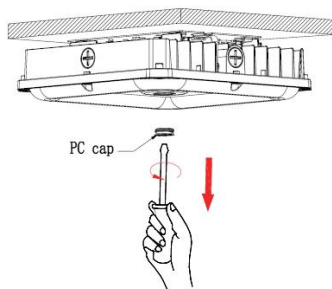

2. Screw the sensor clockwise by hands.

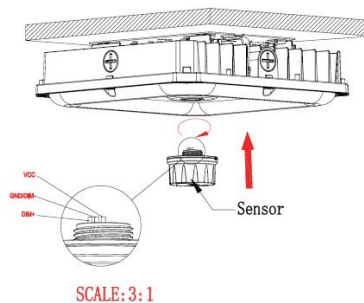

3. After tighten the sensor, lighting the lamp, if the sensor works well, the installation finish.

